

950

950

# Industrial 950

**BERNINA®**

Instruction Manual

Bedienungsanleitung

Manual d' instructions

Manuale d' istruzioni

Manual de instrucciones

950



# IMPORTANT! SAFETY INSTRUCTIONS

GB  
1

The following safety instructions should always be followed:

Before using the machine, read the safety instructions and the instruction manual carefully.

Please follow the instructions below very carefully when setting up, operating and cleaning the appliance!

- Use this appliance only for its intended use as described in this manual.
- Never operate the appliance if parts are defective or missing.
- The appliance may only be operated when all protective covers are correctly fitted.
- The motor voltage mentioned on the specification plate must correspond with the electrical voltage of the place where the appliance is used. Do not use the machine if this is not the case.
- Use only attachments recommended by the manufacturer as contained in this manual.
- Never operate the machine where aerosol (spray products) are being used or where oxygen is being administered.
- Keep flammable and volatile liquids well away from the appliance.
- Switch the machine off or remove the plug from the power supply when making any adjustments in the needle area.
- Always unplug the machine from the electrical supply when cleaning or lubricating or when work is completed. In addition wait until the machine has come to a complete standstill when using a clutch motor.
- Always unplug by grasping the plug and not the cable.
- Do not press the foot control when switching the appliance on.
- The needle and other moving parts (thread take-up, hook and handwheel) are sources of injury (injury to fingers). It is therefore important to keep your eyes on to work.
- Always use the prescribed needle system. Do not use blunt or damaged needles.
- Keep ventilation openings of the motor and foot control free from the accumulation of lint, dust and loose cloth.
- Before tilting the machine, turn the power switch to "0", remove the plug from the power supply and let the machine come to a complete standstill. Be careful of sharp, protruding parts and when tilting the machine back again, make sure that your fingers do not get trapped between the machine and the sewing table.
- Keep these instructions carefully for your own safety.

## DANGER!

When you change the presser foot, it is essential that the finger guard supplied with the machine is attached to the new foot. This does not apply to special presser feet because it would affect their performance, but extra care is required when using these feet.

- 1 Safety Instructions**
- 2 Content**
- 3 Details of the machine**
  - Setting up the machine
- 4 Removing and inserting the bobbin case**
  - Winding the bobbin**
- 5 Inserting the bobbin**
  - Selecting needle and thread**
  - Inserting the needle**
- 6 Changing the presser foot**
  - Threading the upper thread**
  - Bringing up the lower thread**
- 7 Thread tension**
  - Lowering the feed-dog**
  - Presser foot lifter (FHS-Free Hand System)**
  - Sewing tips**
- Standard Accessories
- 8 Presser feet**
- 9 Presser feet**
- Practical sewing
- 10 Practical stitches**
  - Decorative stitches**
- Basic settings
- 11 Straight stitch, zig-zag**
- 12 Practical stitches, decorative stitches**
- Practical sewing
- 13 Sewing with decorative stitches**
- 14 Buttonhole**
- 15 Buttonhole with gimp**
  - Buttonhole foot with slide**
- 16 Blind hem**
  - Vari-Overlock**
- 17 Sewing in zips**
  - Darning**
- Maintenance
- 18 Cleaning, Lubricating**
- 19 Solving problems**
- 20 Index**

# BERNINA Industrial 950

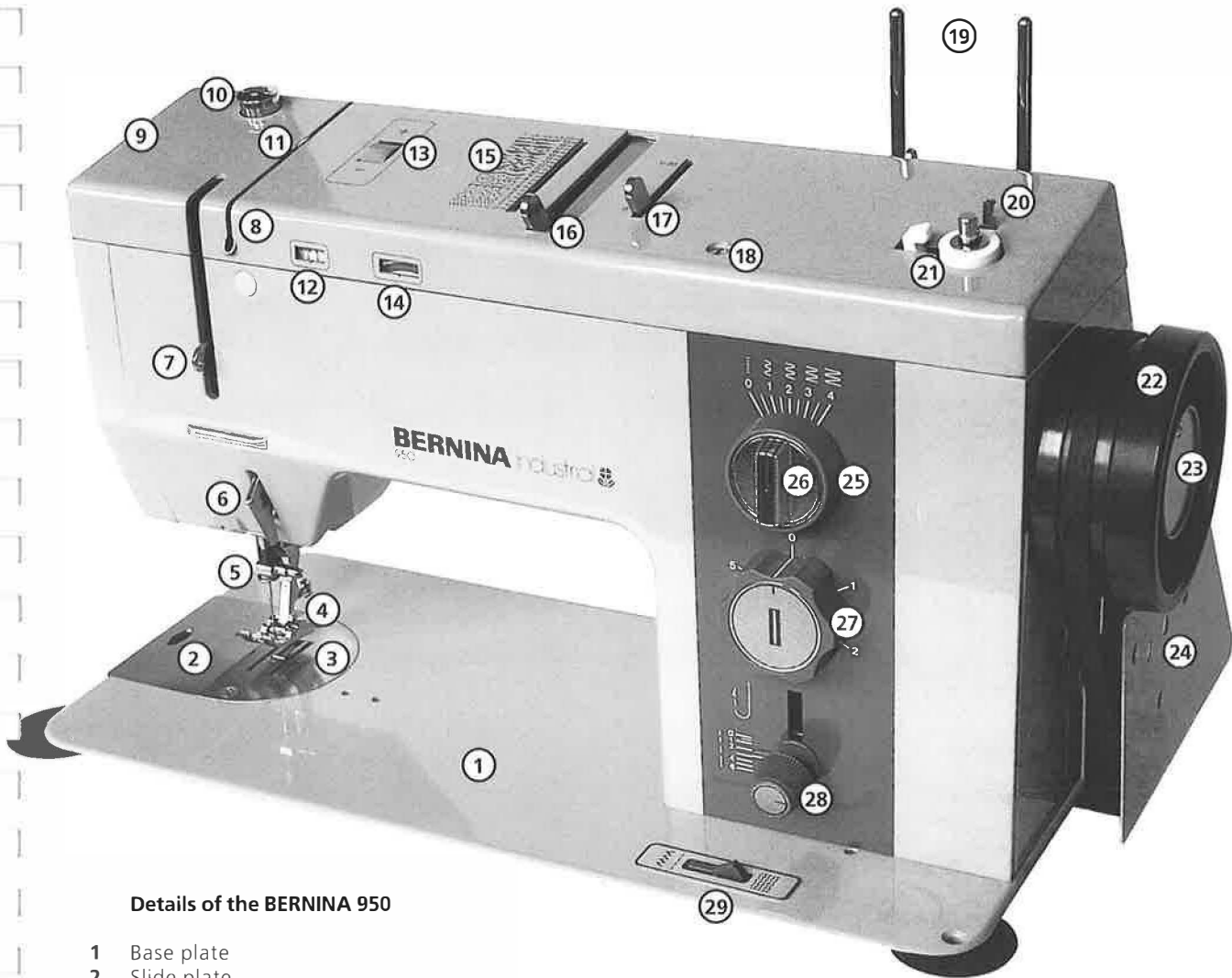

**Details of the BERNINA 950**

- 1 Base plate
- 2 Slide plate
- 3 Stitch plate
- 4 Presser foot
- 5 Needle holder clamp
- 6 Thread regulator
- 7 Thread take-up lever
- 8 Thread tension slit
- 9 Top frame cover
- 10 Pre-tension stud (bayonet fixing)
- 11 Thread tension disc
- 12 Thread tension indicator
- 13 Adjusting wheel for thread tension
- 14 Pattern indicator
- 15 Practical and decorative stitch panel
- 16 Stitch selector
- 17 Stitch converter
- 18 Top frame cover screw (bayonet fixing)
- 19 Spool pins
- 20 Thread cutter
- 21 Bobbin winder
- 22 Handwheel
- 23 Handwheel release
- 24 Drive-belt cover
- 25 Stitch width knob
- 26 Needle position knob
- 27 Buttonhole knob
- 28 Stitch length knob
- 29 Feed-dog switch
- 30 Thread guide
- 31 Presser foot lever



## Removing and inserting the bobbin case

4

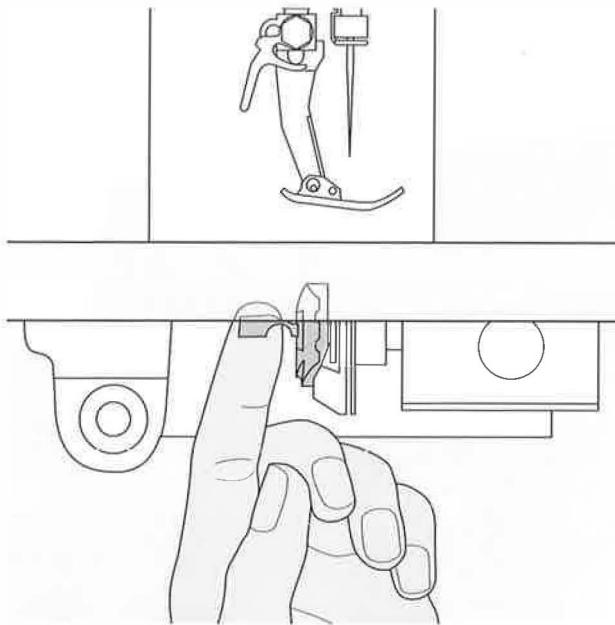

### Removing the bobbin case

Open the slide plate. Hold the bobbin case by the latch with the thumb and forefinger of the left hand and take it out.

### Inserting the bobbin case

Hold the bobbin case latch with the thumb and forefinger of the left hand. Lay the thread over the finger and with the notch at the top, insert the case into the hook so that it engages.

## Winding the lower thread



### Handwheel release

Release the handwheel by turning the knob in the direction of the arrow.

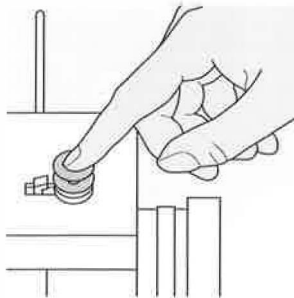

### Winding

Place bobbin on the spindle and press down.

The winding device starts when the motor is put in gear. As soon as the bobbin is full, the winding device switches off automatically.

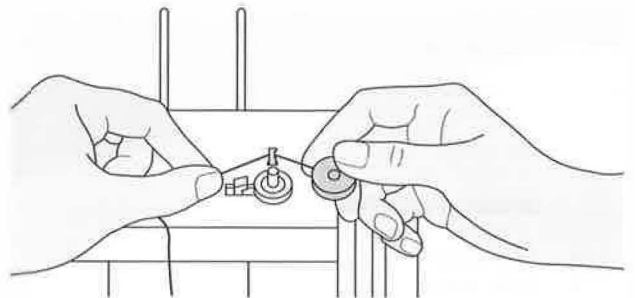

### Thread cutter

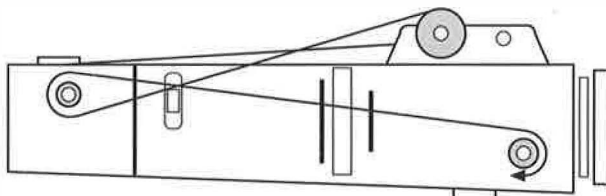

### Guiding the thread

Guide the thread clockwise round the pre-tension stud to the bobbin and wind it clockwise round the bobbin a few times by hand.

### Note:

**Tighten the handwheel release after winding the lower thread.**

## Inserting the bobbin

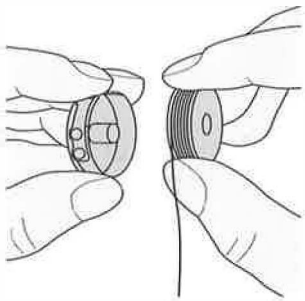

**Inserting**  
Insert the bobbin with the thread running in an anti-clockwise direction.

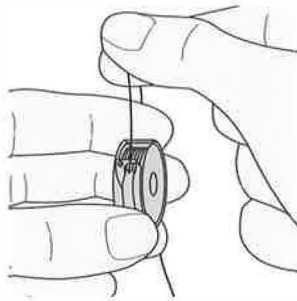

**Threading**  
Draw the thread through the slot and below the spring until it lies in the T-shaped slot at the end of the spring.

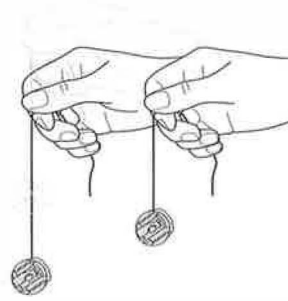

**Lower thread tension**  
Normal tension:  
Sharp hand movement = bobbin case turns  
Hand still = bobbin case still.

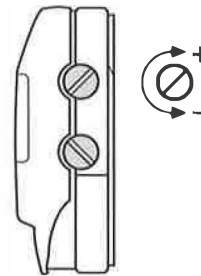

**Adjustment**  
Adjusting the bobbin thread tension:  
+ tighter tension  
- looser tension

## Selecting needle and thread

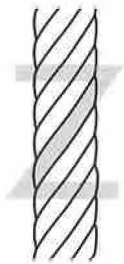

**Selecting needle and thread**  
Use only left-twisted thread. The correct size of needle allows the thread to pass easily through the eye and the long groove. Left or Z twisted.

Needle	70	80	90	100	110 - 120
<b>Thread</b>					
<b>Darning thread</b>	○	○			
<b>Embroidery thread No. 30</b>		○			
<b>Mercerised cotton</b>		○	○		
<b>Polyester</b>		○	○		
<b>Thick mercerised cotton, Polyester</b>			○	○	
<b>Buttonhole thread (cordonnet) for decorative seams</b>				○	○

### Special needles

We recommend the use of special needles which are designed for specific fabrics and materials.



**287 WH SES**  
- fine ballpoint for fine knits and synthetics



**287 WH SUK**  
- medium ballpoint for thick knits



**287 WH L**  
- cutting point for leather, suede, imitation leather and plastic

## Inserting the needle

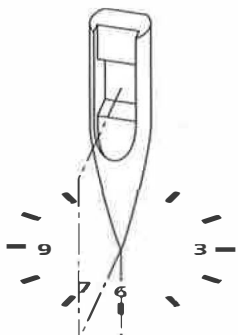

**Needle system 287 WH**  
Insert the needle fully with the long groove to the front. The direction of the eye should be between the 6 and 7 on a clock.

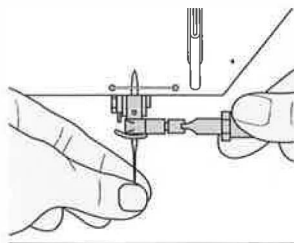

Use the screwdriver from the accessory box to loosen and tighten the needle clamp screw.

## Changing the presser foot

Good sewing results depend on the correct choice of presser foot (see page 9).

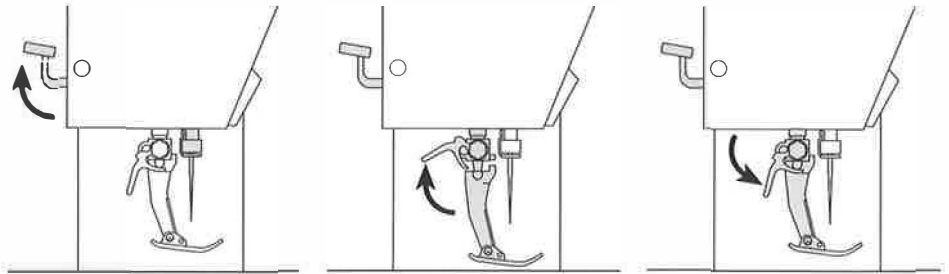

**Raise the presser foot**  
Check that the needle is in its highest position.

**Release the presser foot**

**Attach the presser foot**

## Threading the upper thread

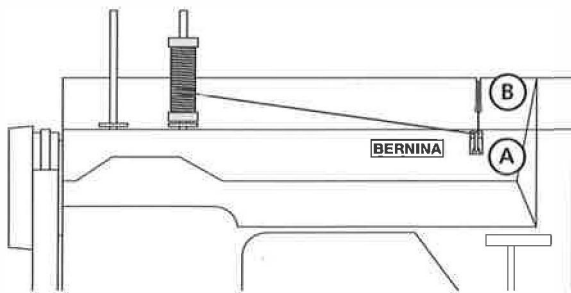

Raise the presser foot.  
Lay the thread in guide **A** on the back of the machine.  
Take it through slit **B**, under the thread regulator **C**, up through the thread take-up lever **D** and down through the thread guide **E** on the needle holder clamp to the needle.

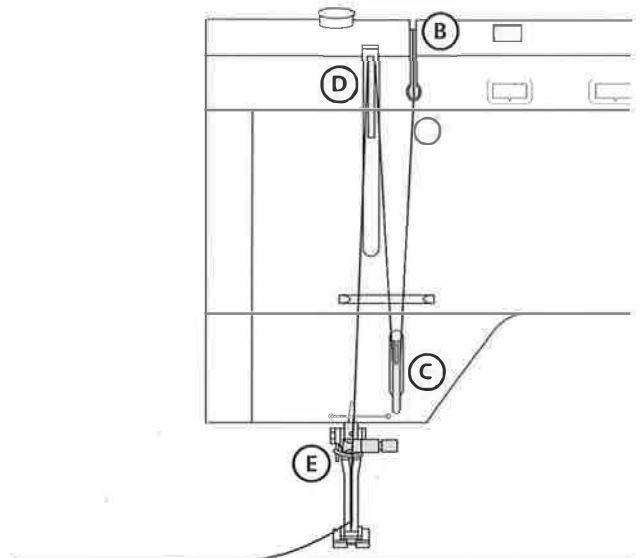

## Bringing up the lower thread

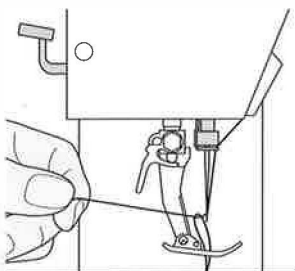

Hold the upper thread loosely.  
Turn the handwheel towards you until the thread take-up lever is in its highest position.  
Pull gently on the thread to bring the lower thread up through the hole in the stitch plate.  
Take both threads through the left slit in the presser foot and place to the left side.



## Thread tension

The tension for normal sewing work is correct when the red line corresponds with the mark.

Use the wheel to adjust the tension for special tasks and fabrics.

The upper thread tension will be looser when the figure 2.5 is in the centre.

The upper thread tension will be tighter when the figure 7.5 is in the centre.



### Do not forget:

Return the tension to its normal position when special sewing is completed.

## Lowering the feed-dog

### Raising the feed-dog

Press the switch to the left.

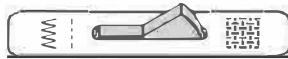

### Lowering the feed-dog

Press the switch to the right for darning, embroidery and sewing on buttons.

## Presser foot lifter (FHS - Free Hand System)

Most sewing tasks are much easier if both hands can be used to guide the fabric. The lifter is operated with the right knee to raise or lower the presser foot, leaving both hands free to guide the work.

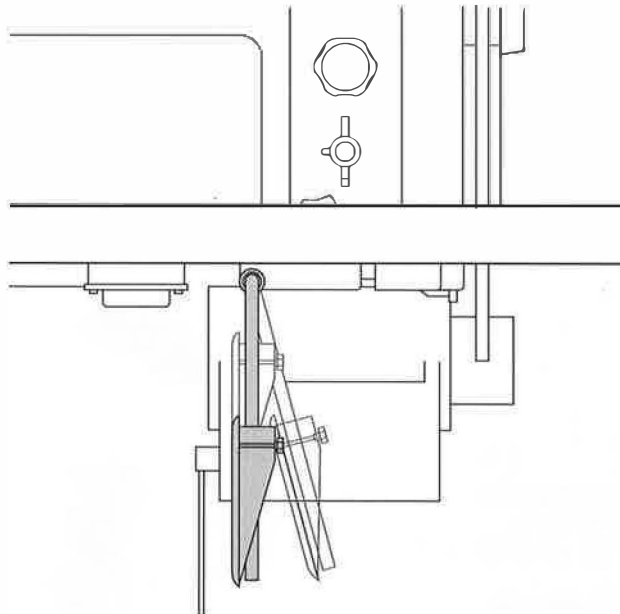

### Attaching the lifter

The opening for the lifter is on the bottom right front of the machine.

The presser foot is held in the raised position.

By pressing the lifter again, the lock is released and the foot is lowered.

The angle of the presser foot lifter can be adjusted to suit the user.

## Sewing tips

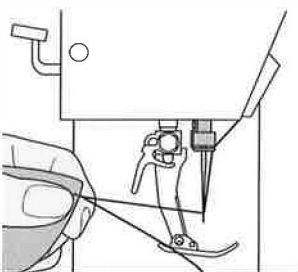

Raise the thread take-up lever before removing the work. This releases the thread which can then be pulled to the back.

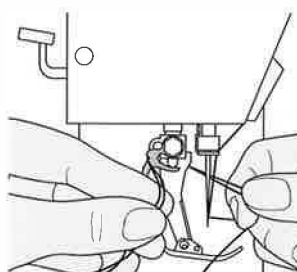

Thread cutter

## Standard presser feet

8

Good results depend on the correct choice of presser foot.  
The presser feet supplied with the machine may differ from country to country.

The BERNINA „Special Accessories“ brochure contains information on around 100 special feet and their uses.

**0**

### Zig-zag foot

All straight stitch and zig-zag work  
Forward feed (Running stitch, Gathering, etc.)

**001 683 7000**

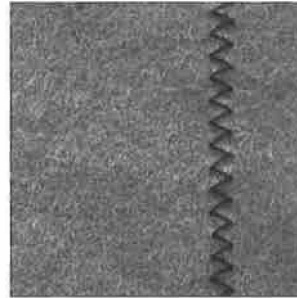

**3 (452)**

### Buttonhole foot

Buttonholes with and without gimp  
Gathering with elastic (single and multiple)  
Gathering with cord

**001 682 7400 (315 452 045)**

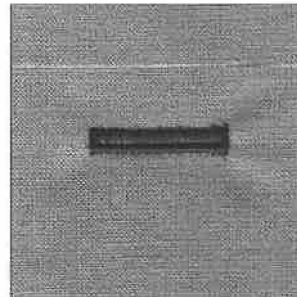

**4 (007)**

### Zip foot

Sewing in zips  
Raised seams

**001 680 7000 (315 007 047)**

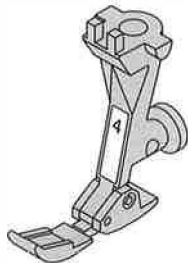

**5**

### Blind hem foot

Blind hems  
Edge stitching

**001 686 7200**

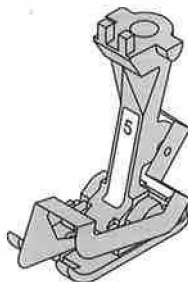

## Standard presser feet

**470**

**Overlock foot**

Overlock seams  
Overlock hems  
Neatening seams  
Narrow satin stitch

**315 470 046**

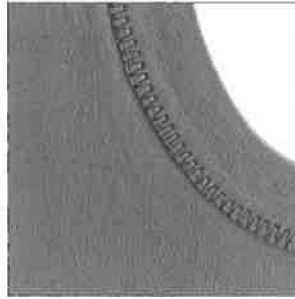
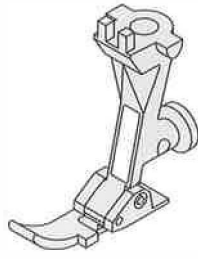

**6 (030)**

**Embroidery foot**

Embroidery with  
decorative stitches  
Satin stitch  
Appliqué  
Couching cord/perle yarn

**001 6854 7000 (315 030 042)**

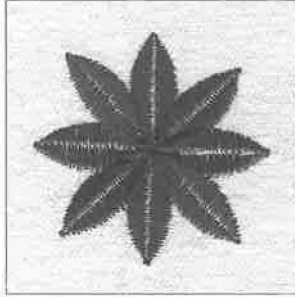

**9 (285)**

**Darning foot**

Darning

**001 675 7000 (315 285 144)**

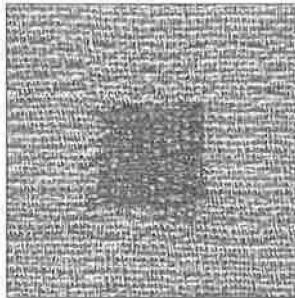

## Practical stitches

10



**1 Sewn-out zig-zag**  
for most types of fabric

Neatening loosely woven fabric, reinforcing edges and patching, decorative seam.



**2 Blind stitch**  
For most types of fabric

Blind hem, shell hem for soft jerseys and fine fabrics, decorative seam.



**3 Universal stitch**  
For firmer knits and wovens as well as felt, leather etc.

Flat joining seams, visible hems, patchwork, mending tricot, sewing on elastic, decorative seam.



**4 Lycra stitch**  
Specially for Lycra and stretch fabrics

Flat joining seam and hems; Reinforcing seams in underwear.



**5 Stretch stitch**  
For stretch fabrics.

Very elastic, open seam ideal for leisure wear.



**6 Gathering**  
For most types of fabric

Gathering with perle yarn Smocking - close gathering of unpressed edges.



**7 Vari-overlock**  
Specially for fine synthetic and silk jerseys, Helanca and fine cotton and wool jerseys

Very stretchy overlock seam and hem particularly suitable for sportswear, pyjamas, T-shirts, pull-overs.



**8 Running stitch**  
For most types of fabric

Darning, mending, reinforcing edges, etc.



**9 Scallop stitch**  
Mainly for wovens

Attractive finish on tablecloths, placemats, collars, cuffs etc.

## Decorative stitches

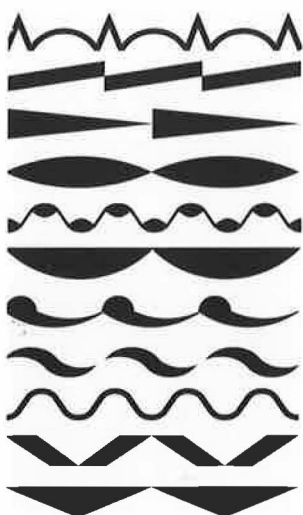

**10-20**  
Decorative stitches

# Straight stitch, zig-zag:

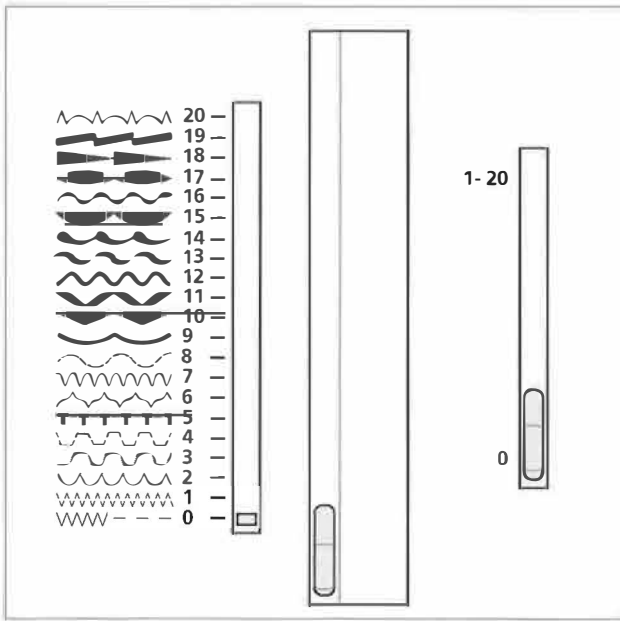

**Basic setting**  
Stitch selector 0  
Stitch converter 0

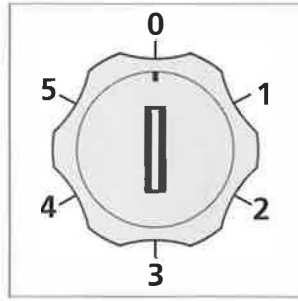

**Basic setting**  
Buttonhole knob 0

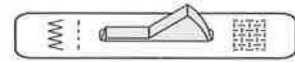

**Basic setting**  
Feed-dog sewing

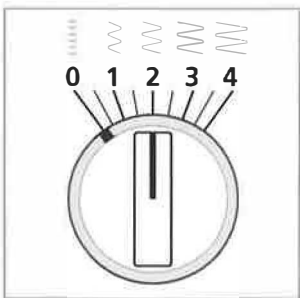

**Straight stitch**  
Stitch width knob 0

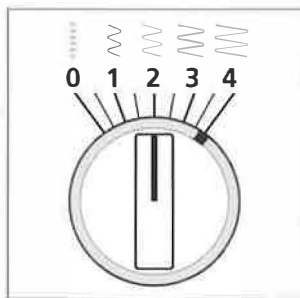

**Zig-zag 0 - 4**  
Turn the knob

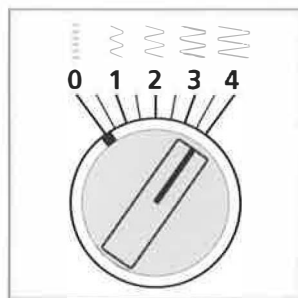

**5 needle positions**  
Turn the indicator

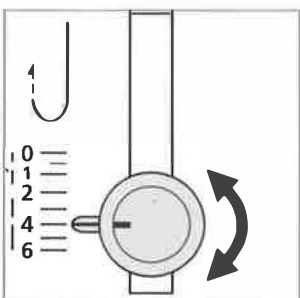

**Stitch length 0-6**  
Turn the knob

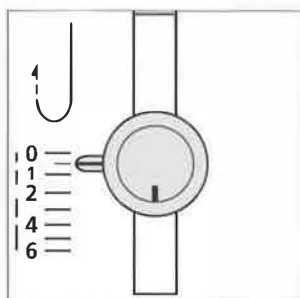

**Satin stitch**  
(dense zig-zag)  
Set zig-zag  
Stitch length approx. 1/2  
depending on fabric and  
thickness of thread

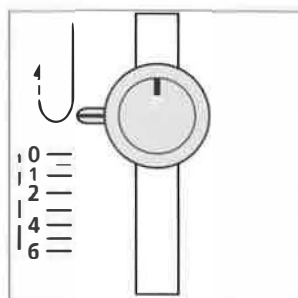

**Reverse sewing**  
Raise the knob fully and  
the machine will sew the  
same stitch length in  
reverse.

## Practical stitches, decorative stitches

12

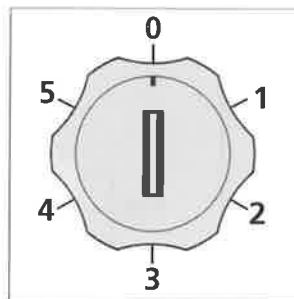
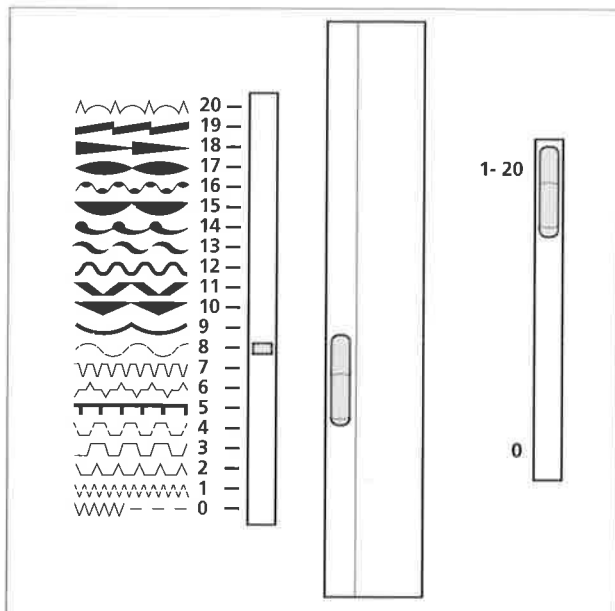

**Basic setting**  
Buttonhole knob 0

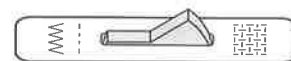

**Basic setting**  
Feed-dog sewing

**Basic setting**  
Stitch converter 1-20

Stitch number	Stitch width	Stitch length	Needle position	Foot
1	4	1	Center	0
2	2 1/2	2 1/2	Right	5
3	4	1	Center	0
4	4	1	Center	0
5	1 3/4	3/4 - 1	Center	0
6	4	1 1/2	Center	0
7	4	1 - 2	Right	470
8	4	1	Center	0
9	4	1/4	Center	6 (030)
10	4	1/4	Center	6 (030)
11	4	1/4	Center	6 (030)
12	4	1/4	Center	6 (030)
13	4	1/4	Center	6 (030)
14	4	1/4	Center	6 (030)
15	4	1/4	Center	6 (030)
16	4	1/4	Center	6 (030)
17	4	1/4	Center	6 (030)
18	4	1/4	Center	6 (030)
19	4	1/4	Center	6 (030)
20	4	1	Center	0

## Embroidery with decorative stitches



### Embroidery foot 6 (030)

Stitch converter: 1-20  
Stitch selector: 9-20  
Stitch width: 4  
Stitch length: approx. 1/2

### Note

To reproduce the embroidery stitch in its full width on fine fabrics, we recommend using backing paper or stabilizer. Embroidery will also be enhanced if special glossy rayon embroidery thread is used.

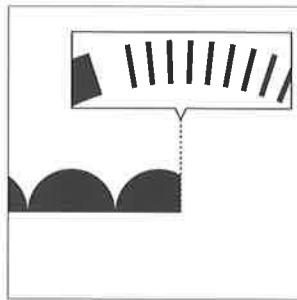
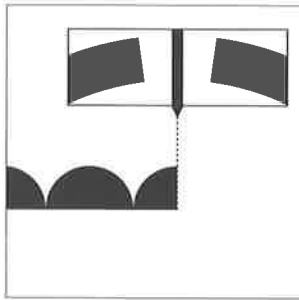
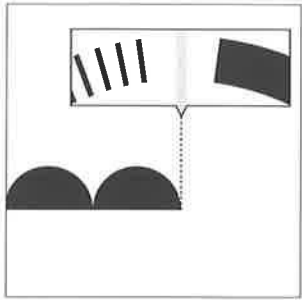

### Pattern repeat

The red line indicates the beginning and end of a pattern.

The thick black line indicates the centre of a pattern.

The fine black lines indicate that the pattern end is coming.

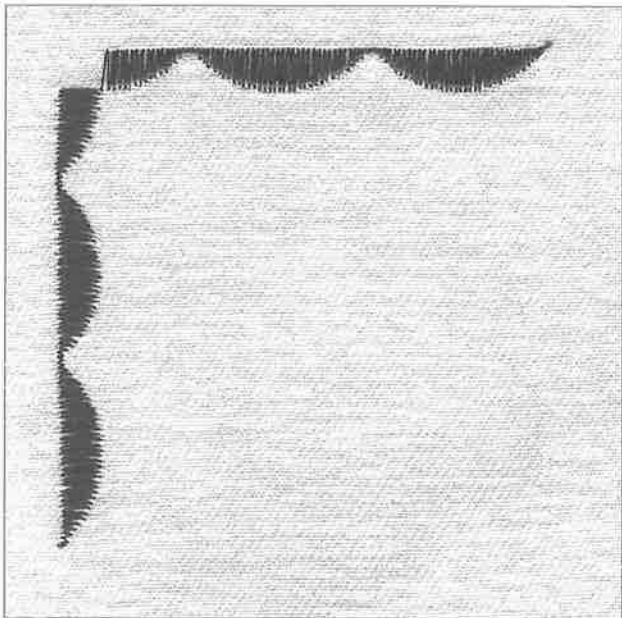

Examples of the pattern repeat.



### Couching

Cord, metal thread, wool etc. can be guided through the hole in the embroidery foot.

# Buttonhole

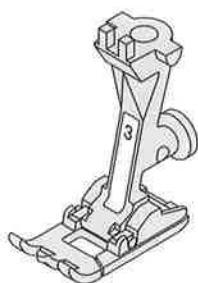

**Presser foot: 3 (452)**

Thread: Machine or embroidery thread  
 Needle: 80 - 70  
 Stitch selector: 0  
 Stitch converter: 0  
 Stitch length: almost 0  
 Feed-dog: raised (sewing)

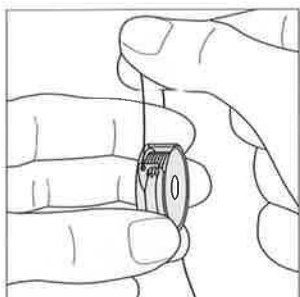

**Bobbin case**  
 When sewing buttonholes, thread the lower thread through the hole in the bobbin case.

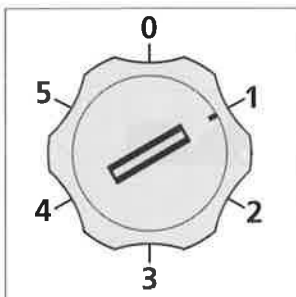

**Buttonhole setting: Buttonhole knob**  
 Turn to position 1.

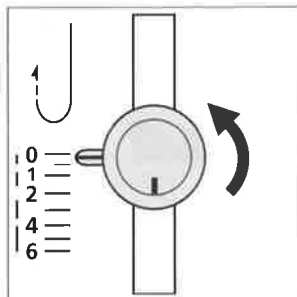

**Adjust stitch length**  
 Turn the knob to the right until it locks. The mark is now at the top and the stitch length is 0.

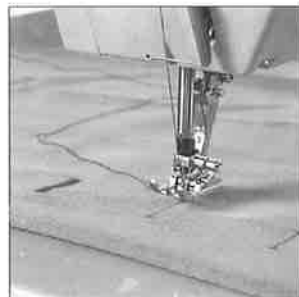

**Sewing the buttonhole**  
 Place the fabric under the foot so that the edge of the fabric lies in front of the foot.  
 Turn the handwheel to move the needle to the right stroke of the zig-zag, i.e. to the centre of the presser foot. Position the fabric so that the needle goes in exactly at the beginning of the buttonhole. Lower the foot and follow the sequence.

Now make a half turn to the left (mark at the bottom) to give the basic setting for the stitch length. Adjust stitch density to suit the fabric: turn a little to left for thick fabrics and a little to right for fine fabrics. Always test sew buttonholes on the fabric you are using.

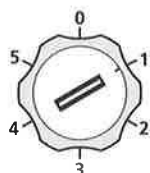

**Knob to 1**  
 Machine sews first bead forwards.

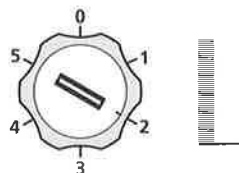

**Knob to 2**  
 Machine sews bartack.

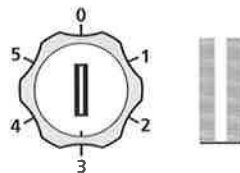

**Knob to 3**  
 Machine sews second bead reverse.

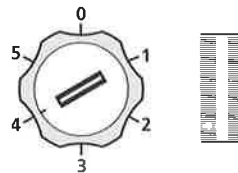

**Knob to 4**  
 Machine sews bartack.

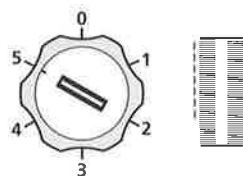

**Knob to 5**  
 Machine sews securing stitches.

**Note:**  
**Only turn the knob when the needle is not in the fabric.**



**Cutting buttonholes open**  
 Cut from the ends towards the centre.



## Buttonholes with gimp

Use gimp for stretchy fabrics so that the buttonhole does not distort.

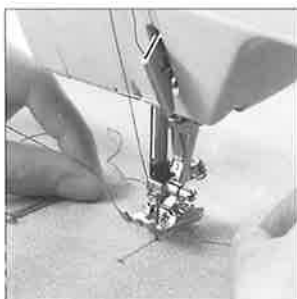

**Placing the cord**  
Place the cord over the centre stem of the foot.

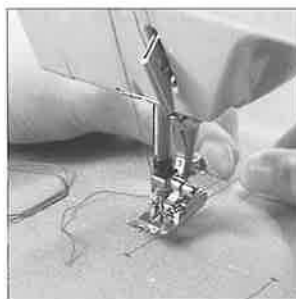

**Sewing the buttonhole**  
Take both ends under the foot to the rear. Lower the foot and check whether the cord slides easily. Sew the buttonhole as described above, holding the cord lightly.

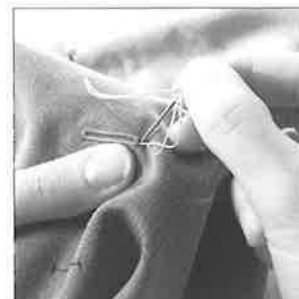

**Knotting the cord-ends**  
Pull the loop into the buttonhole and take the ends of the cord through to the wrong side and knot.

## Buttonhole foot with slide\*

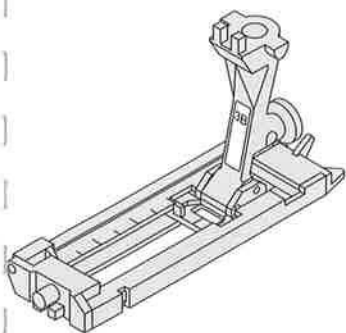

**Presser foot: 3B**

Thread: Machine or embroidery thread  
Needle: 80 - 70  
Stitch selector: 0  
Stitch converter: 0  
Stitch length: almost 0  
Feed-dog: raised (sewing)

**Sew buttonholes as described on page 14.**

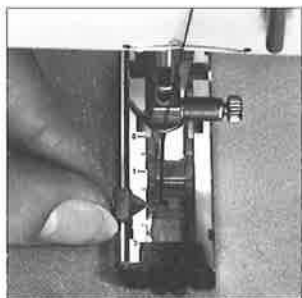

**Marking the length**  
After sewing the first bead, adjust the red slide on the side of the foot to the length of the bead. All further buttonholes will now be sewn to this length.

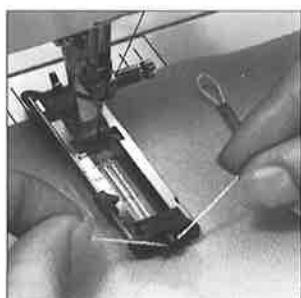

**Slide foot with gimp cord**  
Guide the cord under the foot and hook it over the prong on the back of the foot. Bring the cord under the foot, insert both ends into the front retaining slots and cut. The cord is automatically oversewn when you sew the buttonhole.

\* BERNINA special accessory

## Blind hem

16

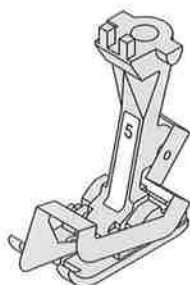

### Blind hem foot (016)

Stitch converter: 1-20  
Stitch selector: 2  
Stitch width: 2 1/2  
Stitch length: 2 1/2  
Needle position: right



#### Preparation

Prepare the hem as for hand sewing, i.e. neaten the raw edge, baste and press. Use fine thread for fine fabrics. Folding the hem,

#### Sewing test

Sew slowly until the needle moves to the left. Turn the handwheel to check that the needle catches the edge of the fabric. If necessary, correct the stitch width.

#### Tip

Hold the fabric back slightly while sewing and guide the folded edge evenly along the guide on the foot to avoid uneven stitches.

## Vari-Overlock

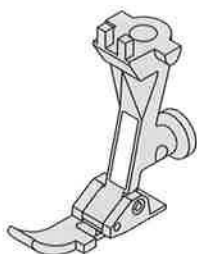

### Overlock foot 470

Stitch converter: 1-20  
Stitch selector: 7  
Stitch width: 4  
Stitch length: 1-2  
Needle position: right

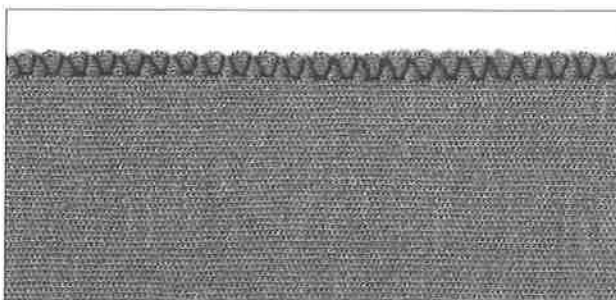

#### Stretchy overlock seam

for fine, soft knits, e.g. silk jersey, tricot, etc.

The overlock stitch is ideal for neatening and sewing seams and hems in one operation. The needle should just go over the edge of the fabric for neatening.

#### Note:

**Use a perfect needle!**  
**Blunt needles will damage the loops and cause holes.**

## Sewing in zips

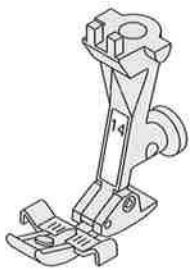

### Zip foot 4 (007) / 14

#### Basic settings

Stitch width: 0  
 Stitch length: 1 1/2 - 2  
 Needle position: right or left accordingly



#### Preparation

Baste the zip seam, press open and then unpick. Baste the closed zip so that the pressed edges remain together and cover the zip teeth.

#### Sewing in the zip

Select the appropriate left or right needle position and sew. To sew past the zip pull, leave the needle in the fabric, raise the presser foot and push the zip pull behind the foot. Lower the foot and continue sewing.

## Darning



### Darning foot 9 (285)

#### Basic settings

Stitch width: 0  
 Stitch length: 0  
 Feed-dog: lowered (Darning)



#### Recommendation

Use a darning ring to tauten the fabric evenly. Hold the ring lightly and move it gently backwards and forwards. Use darning or fine thread. Adjust the upper thread tension so that no knots are formed on either side of the darn.

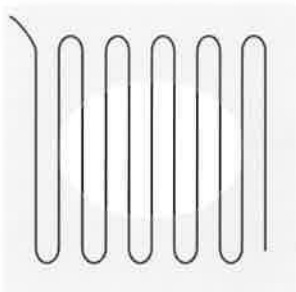

Sew a series of rows over the hole.

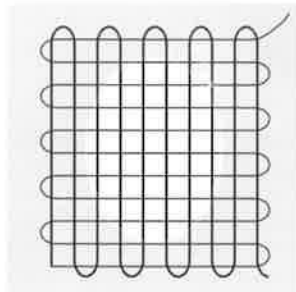

Turn the ring by 1/4 and sew over the previously sewn rows.

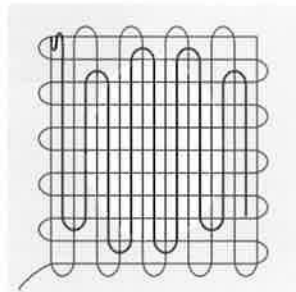

Turn the ring by 1/4 and cover again with rows but not quite so densely.

**Note:**  
 After darning is completed, raise the feed-dog and return the tension to its normal position.

## Cleaning, Lubricating

**ATTENTION:** refer to safety instructions

18



Using the screwdriver press the two screws down and make a half turn to the right (bayonet fixing).

Lift the cover off.

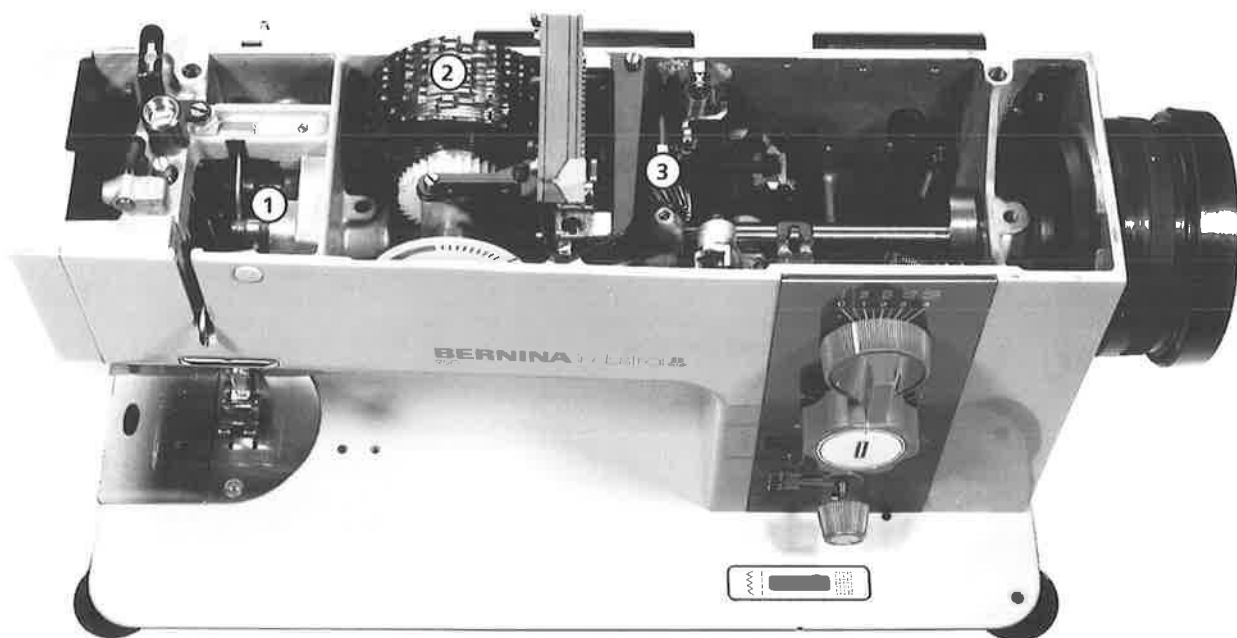

### Lubricating the machine

Use Mobil oil, DTE Heavy or Medium or similar. Lubricate the following points after approx. 50 sewing hours:

1. 5 oil bearings on the thread take-up and needle bar drive
2. Cam block
3. Screw wheel, excenter

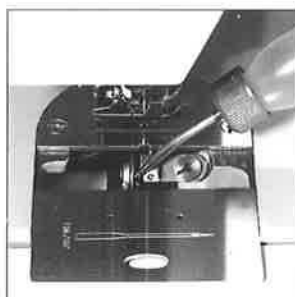

### Lubricating the hook

Use Velocite 10 oil or similar. Pull the lever out and turn the handwheel until the lubricating point on the hook is visible. Oil this point daily

### Cleaning the feed-dog

Remove the stitch plate from time to time and use the brush or a blower to clean the feed-dog and underside of the stitch plate.

## Trouble Shooting

The reasons for most common problems can be found by checking the following list.

### 1. Irregular seam or irregular thread tension

- Check if threading of lower and upper thread is correct.
- The thread is caught on or wound round the spool pin.
- The needle is too fine for the thread.
- The bobbin is damaged and gets stuck in the bobbin case.
- The bobbin thread is wound too loosely.
- The tension is too loose.
- The hook needs lubricating – use thin hook oil (Velocite 10).
- Thread remains in the bobbin case or between the upper thread tension discs.

### 2. Skipped stitches

- Wrong needle system.
- The needle is bent, blunt or incorrectly inserted.
- The needle is too fine for the thread.
- Use the appropriate foot (see pages 8/9 and the BERNINA *Special Accessories* brochure).

### 3. Thread breaks

- Check if threading of upper and lower threads is correct.
- Thread is wound round spool pin.
- Needle problems (see above)
- The tension is too tight for the thread.
- Use left-twisted (Z twisted) thread.
- The thread quality is poor.

### 4. Needle breaks

- Needle problems (see above).
- The needle clamp screw is not properly tightened.
- Sew over seams slowly and check that the needle is not deflected by the thickness.

### 5. Insufficient feed

- Check if the feed-dog (sewing/darning) switch is correctly positioned to sewing.
- Use a special Teflon or Roller foot for fabrics which do not glide easily.

### 6. Machine runs slow

- Check if the handwheel release is tightened.

- Contents** 2
- Couching** 13
- Darning**
  - darning foot 9
  - method 17
- Decorative stitches** 10, 12
- Details of the machine** 3
- Embroidery foot** 13
- Feed-dog**
  - raising 7
  - lowering 7
  - feed-dog switch 3, 7
- Gathering stitch** 10
- Handwheel release** 4
- Hemming** 15
- Lowering the feed-dog** 7
- Lubrication** 18
- Lycra stitch** 10
- Maintenance** 18
- Needle and thread** 5
- Needle positions** 11
- Needles**
  - inserting 5
  - needle and thread 5
- Pattern repeat** 13
- Presser feet-standard** 8, 9
  - blind hem foot
  - buttonhole foot
  - darning foot
  - embroidery foot
  - overlock foot
  - zig-zag foot
  - zip foot
- Presser foot lifter (FHS)**
  - attaching 7
- Reverse sewing** 11
- Running stitch** 10
- Safety instructions** 1
- Satin stitch** 11
- Scallop stitch** 10
- Setting up the machine** 4-7
- Sewn-out zig-zag** 10
- Special accessories** 8
- Stitch converter** 3
- Stitch length** 11
- Stitch selector** 3
- Stitch table** 12
- Stitch width** 12
- Stitches – decorative** 12
- Stitches – practical** 10
  - sewn-out zig-zag
  - blind stitch
  - universal stitch
  - Lycra stitch
  - stretch stitch
  - gathering stitch
  - vari-overlock
  - running stitch
  - scallop stitch
- Straight stitch** 11
- Stretch stitch** 10
- Thread and needle** 5
- Thread cutter** 4, 7
- Thread tension**
  - lower thread 5
  - upper thread 7
- Threading**
  - bobbin thread 5
  - upper thread 6
- Trouble shooting** 19
- Universal stitch** 10
- Upper thread** 7
- Vari-overlock** 10, 16
- Winding the lower thread** 4
- Zig-zag** 11
- Zig-zag foot** 8
- Zip foot** 8
- Zips**
  - sewing in 16